



CITY OF
MONASH

**SPECIFICATION FOR THE CONSTRUCTION OF
CONCRETE VEHICLE CROSSINGS WITHIN THE CITY OF MONASH**

1. GENERAL

The owner or responsible party carrying out the works shall construct a concrete vehicle crossing, properly and evenly screeded, floated and trowelled to a true, level surface. The vehicle crossing shall be true to shape, grade and section, as shown on the standard drawing attached (as applicable) and be constructed to the satisfaction of the Council.

Under the provisions of the Local Government Act 1989, the costs associated with the construction, reconstruction or maintenance of vehicle crossings is the property owner/s responsibility. Council will inspect the vehicle crossing prior to the pouring of concrete and on completion of the works to determine compliance with the specification. It is the responsibility of the owners and/or party responsible for the works to ensure that the crossing is structurally sound, has sufficient depth, strength and width to sustain the intended traffic loads to adequately serve its intended purpose.

It is the responsibility of the party constructing the vehicle crossing to ensure that vehicles can access the site without scraping when the vehicle crossing is completed.

Works found to be non-conforming may be rejected by Council with the owner and/or party responsible for the works being instructed to remove and reconstruct all or that part of the works that does not comply to Council's minimum specification.

Note these Specifications may be updated at any time and it is the responsibility of the person undertaking the works to ensure they are using the most up-to-date version.

Written Approval (Permits)

A Vehicle Crossing Permit is required for all vehicle crossing works. Permits are available from the Monash Civic Centre at 293 Springvale Road, Glen Waverley.

Where approval for a New Vehicle Crossing is conditional on the removal of an Existing Vehicle Crossing to the property, the Existing Vehicle Crossing MUST be removed prior to the pouring of the New Vehicle Crossing.

Vehicle crossings on arterial roads may require Town Planning and VicRoads' approval.

Residential Crossings

Shall be constructed to a **minimum** recommended thickness of 125 mm of concrete.

Commercial and Industrial Crossings

Shall be constructed to a **minimum** recommended thickness of 150 mm of concrete reinforced with SL82 mesh conforming to AS 4671:2001.

Alternatively, un-reinforced concrete of a minimum recommended thickness of 200 mm can be used in lieu of 150 mm, SL82 reinforced.

The above recommendations are not intended to imply that this **thickness** is adequate for the individual needs of the business being conducted from the premises. If there is any doubt that this minimum standard will be adequate for the intended traffic loading generated by the business activities, it is recommended that the services of a qualified engineer be engaged.

2. CROSSING DIMENSIONS AND TYPE

Residential Crossings

The set out details for standard residential vehicle crossings are shown on the attached drawings.

Where extra vehicle crossings are required to a single property or where the widths require the approval of Council, applications for these approvals shall be submitted in writing.

The shape and form of the vehicle crossing is to be as per Council's Standard Drawing C02.

In streets where the "Oakleigh Style" (Standard Drawing C03) is prevalent enquiries should be made with Council's Asset Protection Department or a decision will be made by the Council's Asset Protection Officer at the time of the pre-pour inspection as to what style is used.

Where a double vehicle crossing is required to serve two properties, the minimum width shall be 6.0 metres and maximum width shall be 7.0 metres unless written approval is obtained from Council. Refer to Section 6 for details of how to connect the new part of the vehicle crossing.

Industrial Crossing

All vehicle crossings shall be constructed in accordance with the conditions of the Town Planning Permit issued for the site as applicable, as well as this specification.

3. SITING OF EACH CROSSING

The vehicle crossing shall not be sited closer than 1.0 metre to the property boundary or any significant item of street furniture, drainage or sewerage pit or public authority asset. All vehicle crossings need to be located clear of the drip line of any nature strip tree unless Council dispensation is given. If this clearance cannot be achieved, the matter is to be referred to Council, as a priority prior to proceeding with any works.

If sited within 1.5 metres of an adjoining vehicle crossing, the area between the crossings shall be fully constructed to form a double crossing. If sited between 1.5-2.4 metres of an adjoining vehicle crossing, Council may require the area between the crossings to be fully constructed to form a double crossing.

4. EXISTING CONCRETE AND ASPHALT

- (a) Existing **kerb and channel** is to be removed and reinstated as an integral part of the vehicle crossing. Kerb and channel bays may be saw cut provided greater than 1.0 metre of the existing bay remains.

If less than 1.0 metre of the existing bay remains, then the full length is to be removed.

- (b) Where 75 mm concrete footpath exists which will form part of the vehicle crossing, it shall be broken out to the nearest full bay and replaced with concrete of the same thickness as the vehicle crossing to suite the type of crossing being constructed.
- (c) Where a new vehicle crossing permit is issued and approval is not obtained for the retention of the existing vehicle crossing, the redundant vehicle crossing is to be removed and concrete kerb and channel of the same profile as the existing is to be neatly constructed in its place. The nature strip is to be reinstated: All rock bedding and rubble from the removal of the existing or redundant vehicle crossing within the nature strip is to be replaced with soil with minimum of 75mm thickness topsoil and seed.

- (d) The lip line of the existing kerb and channel **must** be saw-cut to provide a clean, even break between the kerb and channel and the asphalt layers. It is extremely important that care is exercised when removing the existing kerb and channel to avoid any damage to the existing asphalt surface.

Any asphalt that is damaged during the works is required to be neatly saw-cut parallel to the lip for the full width of the vehicle crossing and reinstated with the same size and type of asphalt that has been removed. Refer to page 7 for details of an acceptable repair method for damaged areas. All asphalt reinstatement is to be carried out to Council's satisfaction and any costs incurred by Council in rectifying any asphalt or other damage caused by the owner and/or party responsible for the works will be recouped as a debt owing, as necessary

- (e) New concrete shall be tied into existing concrete using 16mm diameter dowel bars, 300mm long at 300mm centers. Drill and epoxy grout 150mm into the existing concrete. When connecting new kerb and channel with existing kerb and channel a minimum of 2 dowel bars must be used.

All excess concrete, asphalt and other similar materials is to be disposed of at an authorised landfill site.

5. EXCAVATION AND FOUNDATION BED

The area for the vehicle crossing shall be excavated and neatly trimmed to provide for the appropriate depth of concrete plus a minimum compacted depth of 50 mm of Class 2 size 20 mm Fine Crushed Rock bedding is required.

Where the base of the excavation is loose, it shall be compacted with appropriate equipment to provide a firm even surface. The owner and/or party responsible for the works shall spread a layer of fine crushed rock of sufficient thickness to provide a minimum depth of 50 mm after compaction and watering. The bedding shall be finished at a depth below the finished surface level to allow the required minimum recommended thickness of concrete to be placed. All necessary formwork is to be set to line and level and if required, reinforcing mesh cut and placed.

The owner and/or party responsible for the works is to ensure that all these requirements have been fully met before the placement of concrete commences.

6. WIDENING, JOINING OR PARTIAL REPAIR OF EXISTING VEHICLE CROSSING/S

Where an existing vehicle crossing is to be widened (such as creation of a double vehicle crossing) or where part of a vehicle crossing is being repaired, it will be necessary to sawcut the concrete to the nearest joints of the vehicle crossing and tie the new concrete into the existing concrete using 16mm diameter dowel bars, 300mm long at 300mm centers. Drill and epoxy grout 150mm into the existing crossover.

Please note: 16mm dowel bars also required for house drain connections into kerb and channel.

7. WORKSITE TRAFFIC MANAGEMENT

The Works Manager (the person or body that is responsible for the conduct of the works) must ensure that adequate signage, barricades, webbing tape are installed as well as all other obligations are met to comply with the "Road Management Act - Worksite Safety Traffic Management Code of Practice".

A person conducting works in any road reservation must have in operation a traffic management plan prepared in accordance with the "Road Management Act 2004 - Worksite Safety - Traffic Management - Code of Practice".

Provision must be made for all pedestrians who may use the footpath. Note: Pedestrians include, but are not limited to, the frail, elderly, children, visually impaired, wheel chair users and cyclists (children under 12 years of age can use the footpath). Planning and conducting of the works must take these groups into consideration.

The work site is to be properly barricaded whilst work is in progress and/or left unattended with all signing and barricading to conform to the relevant codes and good general work practices.

Weekday works on arterial road reservations may only be undertaken between the hours of 9:00am and 3:30pm to avoid disrupting peak traffic flows.

8. MATERIAL STORAGE

The owner/or party responsible for the works shall not place or dump construction materials on the road pavement, kerb and channel or footpath and shall keep such places clear at all times.

Mixing of mortar or rendering on the road or footpath is prohibited.

9. CONCRETE

Concrete to be used in the construction of the crossing is to be supplied by an appropriate ready mixed concrete manufacturing company.

Consistency & Strength

The consistency of the concrete shall be such that the slump shall not be greater than 80mm nor less than 40mm. The Works Manager responsible for the works must ensure they carry out a check on the delivery docket to ensure conformance of supply, i.e. strength/slump.

The compressive strength of the concrete shall not be less than 32 Mpa when tested after 28 days.

Mixing & Placing

The owner and/or party responsible for the works shall not cause cement or polluted water to fall or run onto the road reserve except for the area of the crossing. Under no circumstances are any materials to be disposed of or washed into the drainage system.

Concrete shall be mixed and placed in a manner to ensure a dense well compacted concrete of the minimum thicknesses specified, true to line, shape and grade.

Curing

Residential and Industrial Crossings

In general, the works should not be trafficked for at least 48 hours after construction, however for industrial crossings, trucks and loaded vehicles should be restricted from using the works for at least seven days after completion.

The owner and/or party responsible for the carrying out of the works assumes responsibility for any damage sustained by the crossing and are liable for any repair works required.

All crossings are to be protected from harsh weather conditions whilst curing either by covering with hessian or spraying with approved curing oils.

The Works Manager responsible for carrying out the works is responsible to check and ensure that any damage from rain, vehicles, vandals, graffiti etc is rectified as soon as possible after completion of the works and prior to the hardening of the concrete surface. These rectification works are to be carried out to the satisfaction of Council.

If the damage is too severe to be adequately repaired or has not been repaired to Council's satisfaction, Council retains the right to instruct the owner and/or party responsible for the works to remove and replace the affected work at their expense.

Surface Finish

A steel trowel finish followed by light brooming is to be achieved unless any other type of finish is specifically nominated or approved by Council.

10. EXPANSION JOINTS

The owner and/or party responsible for the work shall supply and install full depth expansion joints on each side of the crossing adjacent to the footpath. The expansion joints shall be of pre-compressed cork or similar approved material, true to line and level.

11. CLEANING UP

Upon completion of the work, the owner or party responsible for the works shall clean the surface of the existing adjacent footpath, kerb and channel and road surface of any materials associated with the construction of the vehicle crossing or associated works. All naturestrip areas affected by the works shall be levelled, top dressed and seeded, as necessary.

12. INSPECTIONS

Council will conduct two inspections of the crossing. The first (Pre-Pour) inspection shall be undertaken to verify compliance with this specification prior to the pouring of concrete. Preparatory works such as the removal of the kerb and channel, naturestrip and footpath sections are to be undertaken including forming and bedding prior to the inspection. The owner or party responsible for the works is to be present at this inspection.

All inspections are to be booked a minimum of 24 hours (1 working day) in advance of the time required. Contact Council's Customer Service Centre on 9518 3555 to arrange the inspection. The latest time a booking may be booked for an inspection is 2.00pm on the working day prior to the inspection. Inspections are only undertaken in the morning from Monday to Friday. Where additional inspections are required before pouring of the vehicle crossing these must be booked separately.

On the approval of the inspector, the crossing can be constructed.

The inspector will undertake a Final Inspection 3-4 weeks after the Pre-Pour Inspection. No booking is required as this inspection is undertaken automatically. The Inspector will inform the Owner/Works Manager of any works that require to be undertaken to meet the Council requirements.

13. DRAINAGE CONNECTIONS

House drains that are to be installed into the kerb and channel adjacent to the vehicle crossing must be at least 1.0m away from the edge of the vehicle crossing at the kerb unless a cast iron pipe and cast iron kerb adaptor is installed in lieu of a uPVC Sewer Quality Pipe and Council approved Kerb Adaptor.

14. WORKS MANAGER - RESPONSIBILITIES

The Works Manager is any person or body that is responsible for the conducting of works in, on or under the road. (Road Management Act – Schedule 7, Clause 14).

Principles applying to infrastructure managers and works managers:

- (1) An infrastructure manager or a works manager must have regard to the principles specified in this clause in the provision of non-road infrastructure on roads.

- (2) The primary purpose of a road is use by members of the public and authorised users must be managed as far as is reasonably practicable in such a way as to minimise any adverse impacts on the primary purpose.
- (3) Without limiting the generality of sub-clause (2), authorised uses must be managed so as to:
- a. minimise any damage to roads and road infrastructure;
 - b. ensure that works necessary for the provision of non-road infrastructure are conducted as quickly as practicable;
 - c. minimise any disruption to road users;
 - ca. minimize any disruption to users of different modes of transport which have a priority on specified roads;
 - d. minimise any risk to the safety and property of road users and the public generally;
 - e. facilitate the design and installation of infrastructure which minimises any risk to the safety of road users;
 - f. ensure that the road and any other infrastructure is reinstated as nearly as practicable to the condition existing before the works necessary for the provision of the non-road infrastructure were conducted;
 - g. protect and preserve existing significant roadside vegetation and sites of biological significance within the road reserve.

(Road Management Act 2004 - Schedule 7, Sec 14)

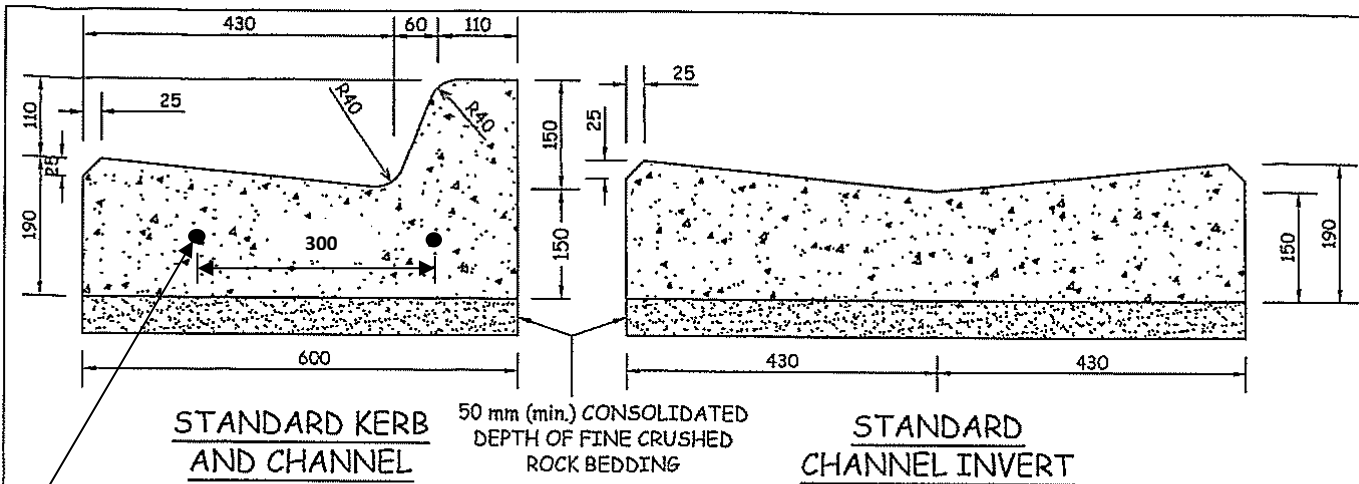

STANDARD KERB AND CHANNEL

50 mm (min.) CONSOLIDATED DEPTH OF FINE CRUSHED ROCK BEDDING

STANDARD CHANNEL INVERT

NEW CONCRETE SHALL BE TIED INTO EXISTING CONCRETE USING 16MM DIAMETER DOWEL BARS, 300MM LONG AT 300MM CENTERS. REFER TO SECTION 4(E) FOR FURTHER DETAILS.

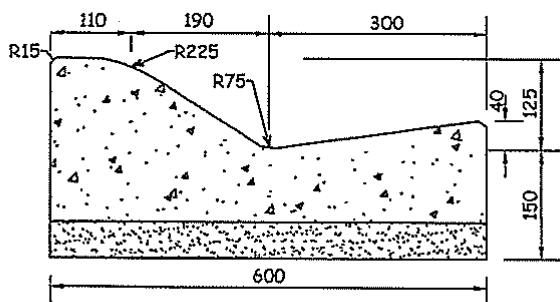

SEMI-MOUNTABLE VICROADS SM2 KERB

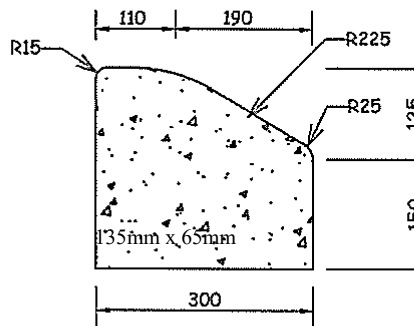

VICROADS SM1 KERB

FOOTPATH DETAIL

NEW SUBDIVISIONS &

SHARED PATHWAY: 125mm DEPTH

EXISTING PATHS: 75mm DEPTH

ALL FOOTPATHS TO BE 1.4m WIDTH

MAXIMUM CROSSFALL 1:40 (2.5%)

CONTRACTION JOINTS TOOLED AT 1.5m SPACINGS AS PER COM STD C09 PROVISION FOR TREE ROOTS UNDER CONCRETE PATHS.

LIGHT BROOM FINISH ACROSS PATH.

SAWCUT FOR SHARED PATHS.

ALL CONCRETE PAVING TO BE N32 (min.) STRENGTH GRADE

CONSTRUCT TO INCLUDE TRIP STOP AS PER COM STD C09 OR AS SPECIFIED BY COUNCIL

KERBING DETAIL

ALL KERBING TO BE N32 (min.) STRENGTH GRADE.

ALL KERBING TO HAVE STEEL TROWEL FINISH.

KERB REPLACEMENT TO BE TO FULL BAYS TO NEAREST JOINT.

FOR HOUSE DRAIN CONNECTION TO THE KERB REFER TO STD DWG D7

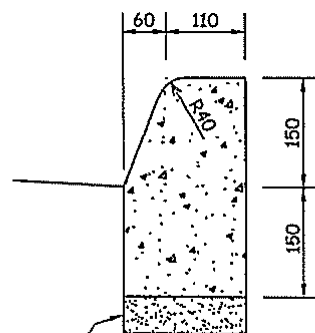

STANDARD KERBING

GENERAL

EXPANSION JOINTS IN FOOTPATHS & KERBS TO BE PLACED AT 20 m (max.) SPACING.

50 mm (min.) FINE CRUSHED ROCK BEDDING UNDER ALL CONCRETE.

CITY OF MONASH 

CONCRETE KERB AND FOOTPATH DETAILS

DIRECTOR INFRASTRUCTURE:

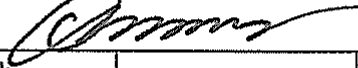

DRAWN:
W.Du FEB 2011

SCALE: N.T.S.

SHEET:

DWG NAME:
STDWG C1

21500

C 01
REV: D JUN15

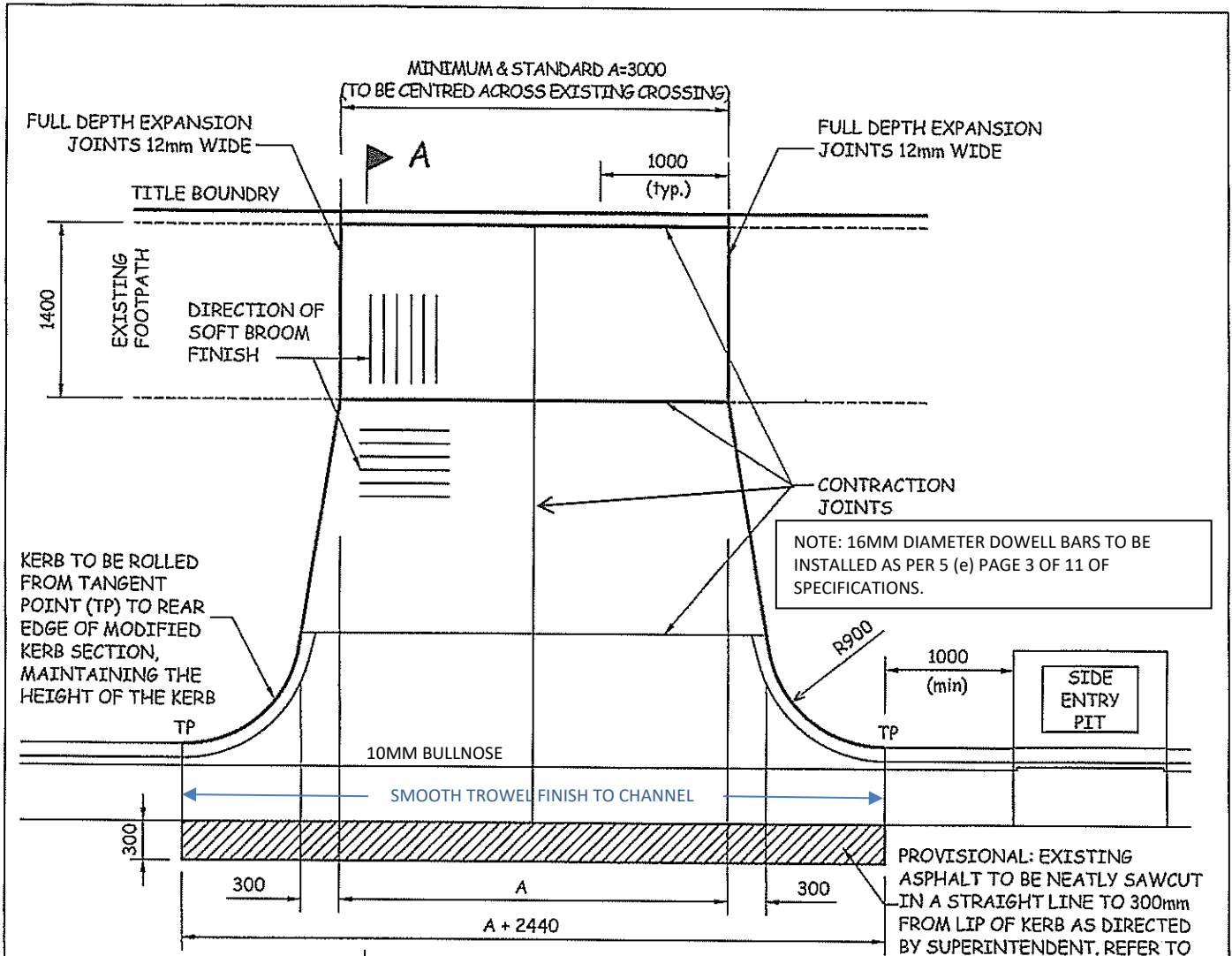

A PLAN

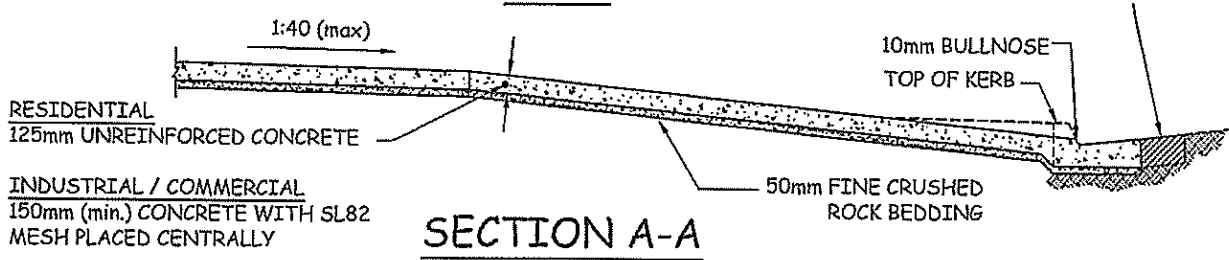

NOTES

- 1 ALL CROSSINGS TO HAVE SOFT BROOM FINISH
- 2 FOOTPATH AND DRIVEWAYS TO BE N32 (Min.) STRENGTH GRADE
- 3 MODIFIED KERB & CHANNEL TO BE N32 (Min.) STRENGTH GRADE
- 4 WHERE THE FOOTPATH WIDTH VARIES, APPLY A 2:1 RATIO TO THE ALTERNATING HERITAGE PATTERN ALONG THE FOOTPATH
- 5 NOT ALL PITS WILL COMPLY WITH THE 1000mm MINIMUM OFFSET FROM TP OF CROSSOVERS. WHERE THIS IS THE CASE, SIDE ENTRY PIT TO BE FITTED WITH MEDIUM DUTY CAST IRON LID.
- 6 WHERE CROSSING WIDTH AT PROPERTY LINE IS GREATER THAN 3000mm (SHOWN AS 'A' IN PLAN), 'A' WILL THEN EQUAL THE EXISTING WIDTH DIMENSION.

CITY OF MONASH

STANDARD VEHICULAR CROSSING IN PRIVATE STREETS

DIRECTOR INFRASTRUCTURE:

DRAWN:
W.Du Feb 2011

SCALE: N.T.S.

SHEET:

DWG NAME:
STDWG C2

21500

C 02

REV: C JUN15

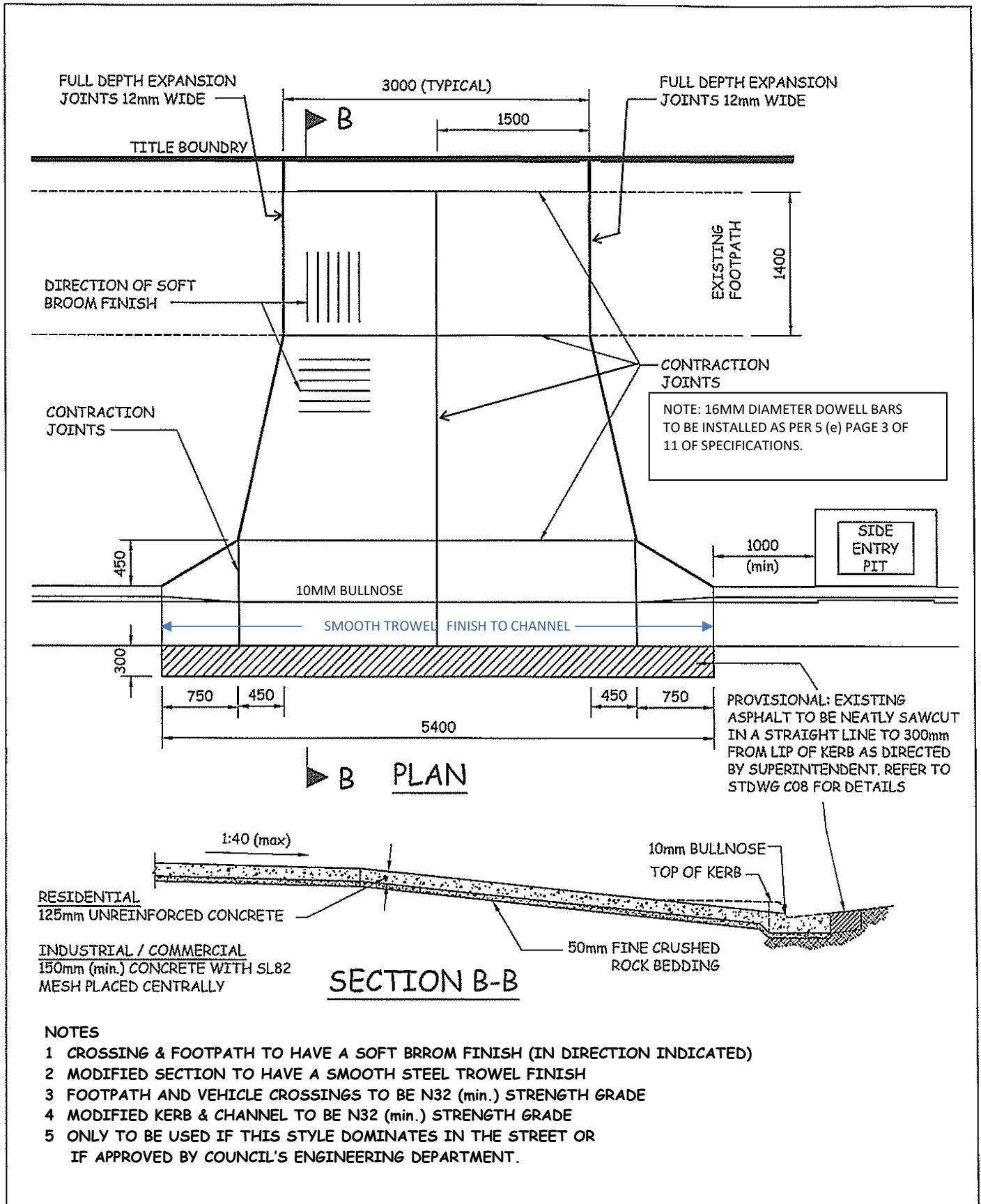

CITY OF MONASH

VEHICLE CROSSING
Refer to Note 5 regarding usage
'OAKLEIGH STYLE'

| | | |
|--|------------|---------------------|
| DIRECTOR INFRASTRUCTURE: <i>Clayton</i> | | |
| DRAWN: W.Du Feb 2011 | SCALE: NTS | SHEET: |
| DWG NAME: STDWG C3 | 21500 | C 03 REV:C JUN15 |

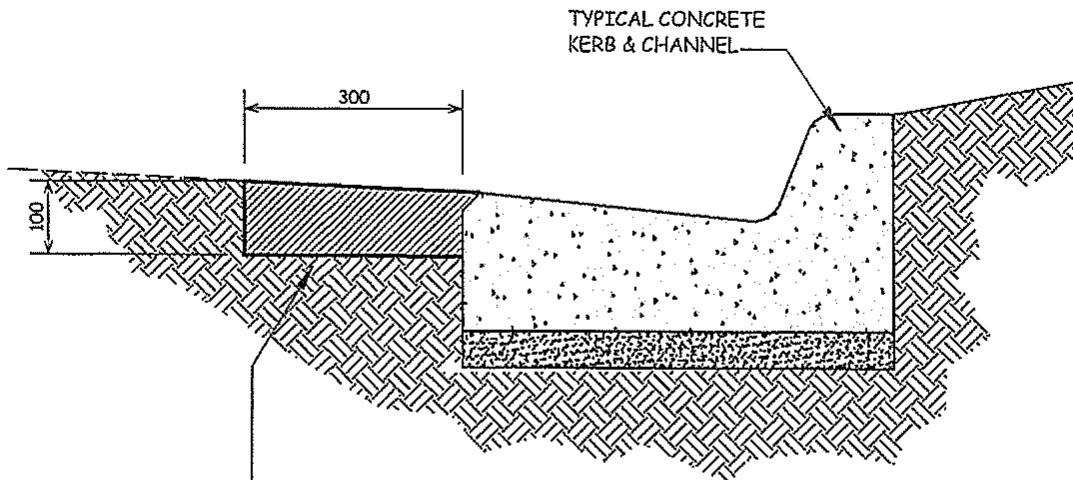

PROVISIONAL: CONSOLIDATED ASPHALT OF SIZE 10, TYPE N (CLASS 170) IN RESIDENTIAL ROADS TO SMOOTHLY MATCH TO EXISTING PAVEMENT LEVELS WITHOUT ANY DISCONTINUITY

NOTE:

THE EXISTING ASPHALT ROAD SURFACE IS TO BE NEATLY SAW CUT STRAIGHT TO A DEPTH OF 100mm AND 300mm WIDE FROM THE EDGE OF THE LIP OF THE CONCRETE KERB & CHANNEL.

WHEN THE KERB & CHANNEL OR MODIFIED KERB & CHANNEL FOR THE CROSSING IS CONSTRUCTED THE PAVEMENT IS TO BE REPLACED WITH 100mm CONSOLIDATED ASPHALT IN TWO 50mm LAYERS AS NOTED ABOVE.

ALL UNITS IN MILLIMETRES UNLESS NOTED OTHERWISE

CITY OF MONASH 

ASPHALT PAVEMENT REPLACEMENT IN FRONT OF LIP

DIRECTOR INFRASTRUCTURE:

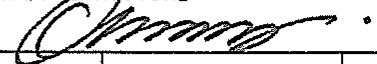

DRAWN:
W.Du Feb 2011

SCALE: N.T.S.

SHEET:

DWG NAME:
STDWG C08

21500

C 08

REV: B JUN 15

APPROVED P.V.C. 135 x 65mm SEWER
QUALITY KERB ADAPTER TO BE USED

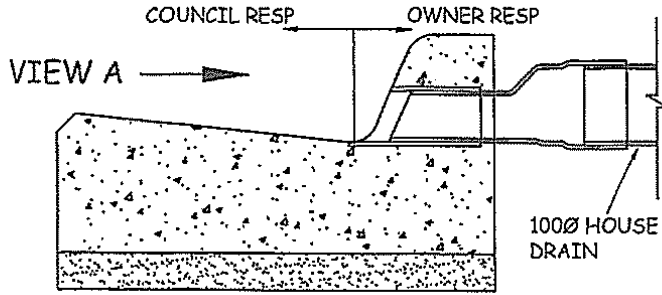

HOUSE DRAIN CONNECTION

WHERE APPROVED
(IF NO UNDERGROUND CONNECTION)

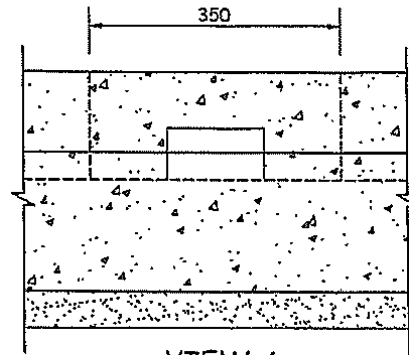

VIEW A

NOTE:

1. SAWCUT AND REMOVE 350mm (MIN.) SECTION OF KERB TO PROVIDE ADEQUATE WIDTH BOTH SIDES OF THE CENTRALLY PLACED KERB ADAPTOR FOR REINSTATEMENT OF THE KERB.
2. THE NEW KERB IS TO BE TIED INTO EXISTING KERB USING 8mm Ø DOWEL BARS 150mm LONG. DRILL AND EPOXY GROUT 75mm INTO THE EXISTING CONCRETE.
3. INSTALL KERB ADAPTOR AND 100Ø HOUSE DRAIN AT LEAST 1.0m AWAY FROM THE EDGE OF THE VEHICLE CROSSING AT THE KERB OTHERWISE A CAST IRON PIPE IS TO BE INSTALLED IN LIEU OF UPVC SEWER QUALITY PIPE.
4. MINIMUM CONCRETE STRENGTH OF 32 MPa.

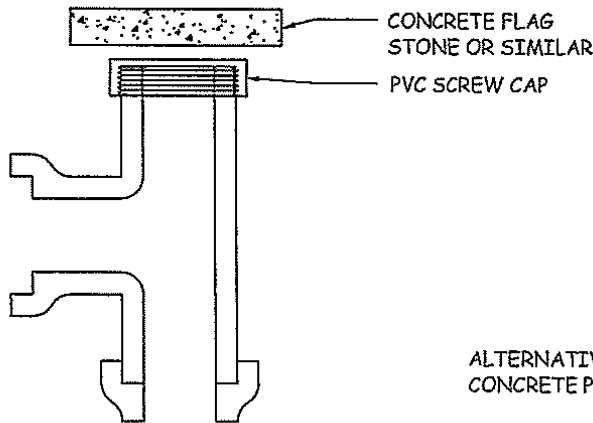

STANDARD HOUSE DRAIN CONNECTION (WITHIN ROAD RESERVE)

NOTE:
BACKFILL UNDER THE BASIN IS TO BE PACKING SAND THOROUGHLY COMPACTED

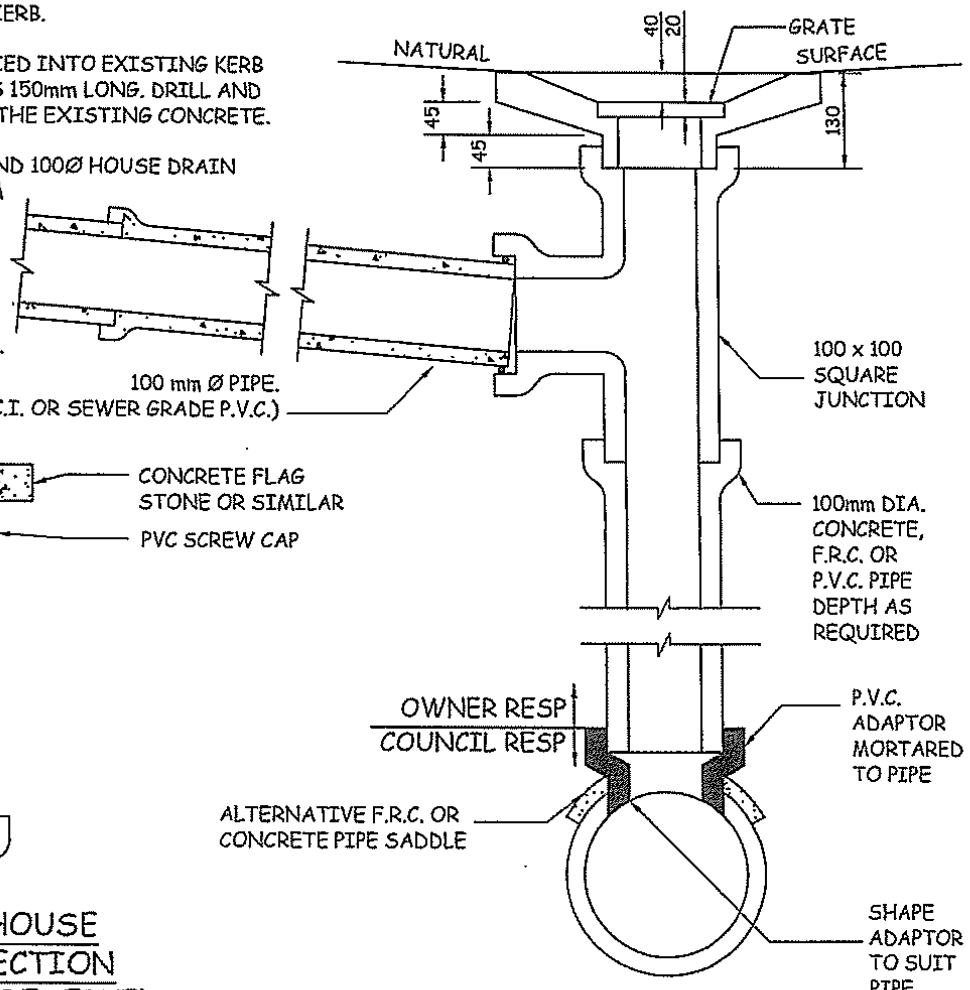

STANDARD HOUSE DRAIN CONNECTION (WITHIN EASEMENT)

CITY OF MONASH



PROPERTY INLETS

DIRECTOR INFRASTRUCTURE:

[Signature]

DRAWN:
W.Du Feb 2011

SCALE: 1:10

SHEET:

DWG NAME:
STDWG D07

21500

D 07

REV:C JUN15